

Sheng Yao Wang (Dalian) International Trade Co., LTD.



Manager Card



International site

Sheng Yao Wang (Dalian) International Trade Co., LTD.

Phone:86-0411-88700549

Email:lindseyzhang@shengyaowang.com

Add: tiger town, Wafangdian, Dalian, China

Official website: www.sunbearing.net





CONTENTS

1. Deep groove ball bearing
2. Double row angular contact ball bearings
3. Spherical roller thrust bearings
4. Aligning roller bearings
5. Cylindrical roller bearings
6. Tapered roller bearing
7. Four row taper roller bearings
8. Pillow block bearings
9. Manufacturer
10. Production process
11. Application
12. Show

▶▶▶▶ About sunbearing



Sheng Yao Wang (Dalian) International Trade Co., LTD. was founded in 1999, has been focusing business of bearing production and trade for 18 years, has rich experiences in bearing processing and trade and become the major bearing manufacturer. We can provide clients with professional bearing application solutions. In china, we have many famous clients, such as the one of Chinese largest manufacturer of steel- CIMC, Japanese TV manufacturer-TOSHIBA and electrical machinery manufacturer- FUJI ELECTRIC and so on. We not only won widespread praise in the domestic market, also gain the recognition of foreign market, such as Britain, Africa and southeast Asia market .

Our goal is to cooperate with leading domestic and international enterprises to develop in win-win model and create a mutually beneficial future.

Sales of different goods

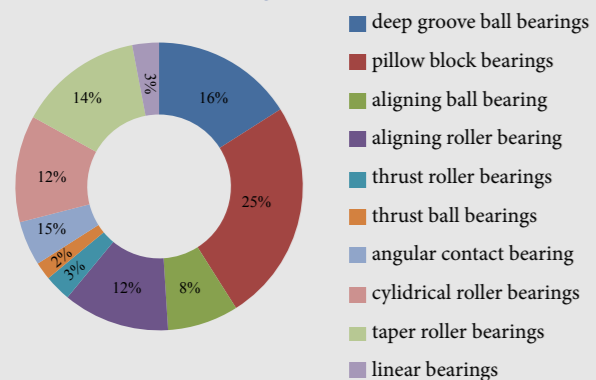

Sales in different industries

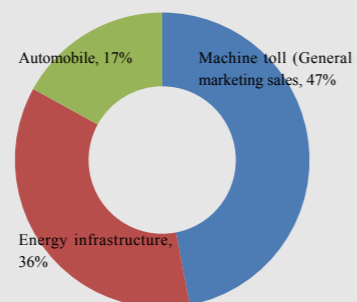

Overseas sales in different regions

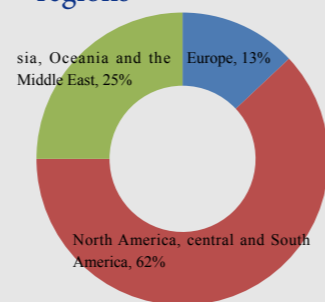

Deep groove ball bearing

Deep groove ball bearings belongs non-separable bearings. They mainly bear radial load and also bear certain axial load. Such kind of bearings have features of small friction coefficient, high speed limit and diversified dimensional range and type.

SUNBEARING deep groove ball bearing are used as locating bearings in equipments of iron-rolling mill and are often used at drive end of roller.

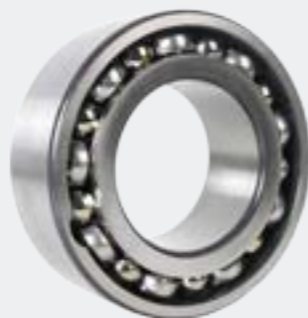

Aligning roller bearings

Aligning roller bearings have two rows of roller, so generally they can bear bigger radial load. Outer and inner rings matched the aligning roller which have property of automatic aligning.

SUNBEARING has many series of aligning roller bearings. They can be used in a variety of load and speed applications.

In this series of product include two main designs: CJ series and YM/YMB series. About the inner of CJ series, it has a windowed, sheet metal pressed and steel making cage. They have long life and load capacity. About the inner of YM series, it has the cage supported by the roller and with the precision production for the harsh application.



Series	Bore Diameter : mm	Variant Structure
61800	110~1280	Z、2Z、RZ、2RZ
61900	100~1280	Z、2Z、RZ、2RZ、 N、NR、ZN、RZN
16000	100~1000	
6000	100~1180	Z、2Z、RZ、2RZ RS、2RS、N、NR、ZN、RZN
6200	100~400	Z、2Z、RZ、2RZ RS、2RS、N、NR、ZN、RZN
6300	100~400	Z、2Z、RZ、2RZ RS、2RS、N、NR、ZN、RZN
6400	100~400	N、NR

Series	Bore Diamete	Variant Structure
22200	100~400	K、 /W33、 K/W33
22300	100~400	K、 /W33、 K/W33
23000	100~1180	K、 /W33、 K/W33
23100	100~1180	K、 /W33、 K/W33
23200	100~800	K、 /W33、 K/W33
24000	100~1180	K、 /W33、 K/W33
24100	100~1180	K、 /W33、 K/W33
23900	180~1180	K、 /W33、 K/W33
23800	180~1180	K、 /W33、 K/W33
21300	120~800	K、 /W33、 K/W33
Seal Structure		
All Series	100~1180	K、 /W33、 K/W33
Split type		
SSRB	120~1120	

Cylindrical roller bearings

Cylindrical roller bearings belong to separable bearings. They are mainly used for medium and large sized power generator, internal combustion engine, combustion turbine, machine tool spindle, reduction gear, loading and transporting machine and each kind of industrial machinery.

Split cylindrical roller bearings are mainly used for crank and the position where bearings are difficult to be installed and are mainly used for fields such as cold rolling mill crank of piggy steel tube, spine shaft, excavator, transmission mast of rolling mill and large sized ventilation equipment.

SUNBEARING also can provide special single row cylindrical roller bearing for vibrating screen or other oscillating machinery, adopting turned solid brass cage. Radial clearance often adopts C4 group.

Full complement cylindrical roller bearings are designed to bear heavy load. Under same width, such bearings have extremely high bearing capacity, small radial cross section and saving space but relatively low rotation speed compared with traditional bearings with cage.



Series	Bore Diameter	Variant Structure	Series	Bore Diameter	Variant Structure
		Single row	NNU4100	100~1180	K、/W33、K/W33
200E	80~1120	N、NF、NJ、NU、NUP	NNU4800	100~1180	K、/W33、K/W33
300E	80~1120	N、NF、NJ、NU、NUP	NNU4900	100~1180	K、/W33、K/W33
400E	100~1120	N、NF、NJ、NU、NUP	Single row		
1000E	100~1120	N、NF、NJ、NU、NUP	1800V	150~1000	NC、NCF、NJ
1900E	150~1120	N、NF、NJ、NU、NUP	2300V	80~1000	NC、NCF、NJ
2900E	150~1120	N、NF、NJ、NU、NUP	2800V	80~1000	NC、NCF、NJ
3800E	300~1120	N、NF、NJ、NU、NUP	2900V	80~1000	NC、NCF、NJ
2200E	100~1120	N、NF、NJ、NU、NUP	3000V	80~1000	NC、NCF、NJ
2300E	100~1120	N、NF、NJ、NU、NUP	Double row		
		Single row, Split type	4800V	150~530	NNC、NNCF、NNCL、NNF
SCRB	220~1120		4900V	80~530	NNC、NNCF、NNCL、NNF
		Double row	5000V	80~530	NNC、NNCF、NNCL、NNF
NN3000	100~1180	K、/W33、K/W33			



Double row angular contact ball bearings

Double row angular contact ball bearings can bear bigger radial and axial joint load and moment load with radial load as main subject. They are mainly used in parts limiting bi-directional axial displacement of shaft or housing.



Series Contact Angle	Mm Bore Diameter
$\beta=30^\circ$	
3200A	100~400
3300A	100~400
$\beta=40^\circ$	
4000/DC	120~600
4900/DC	160~600
$\beta=50^\circ$	
4000D	120~600
4900D	160~600

Spherical roller thrust bearings

Spherical roller thrust bearings are separable bearings. Roller is spherical ; housing washer raceway is spherical. They have performance of aligning , very big ability of bearing axial load, and can also bear some radial loads at the same time. Oil lubrication is often adopted. They are mainly used for hydro power generator, vertical motor, screw shaft used for ship, tower crane and extruder etc.



Series	mm Bore Diameter
29200E	100~1180
29300E	100~950
29400E	100~950



Tapered roller bearing

Taper roller bearings are mainly used for radial and axial joint load with radial load as main subject. Axial load capacity relies on raceway angle of outer ring: the bigger the angle is, the bigger the bearing capacity is. Outer ring can be separated and can be easily assembled. During installing and using process, axial clearance and radial clearance can be adjusted and pre-interference installation can be allowed.

When double row taper roller bearings bear radial load, they also can bear bi-directional axial load and can limit bi-directional axial displacement of shaft or housing within axial clearance of bearings. They are generally applicable to the site of medium and low speed.

SUNBEARING taper roller bearings play an essential role in reducing the time downtime, extending the life and ensuring effective operation of equipment.



Series	Bore Diameter mm)	Series	Bore Dismeter (mm)
Single row, Metric series		Single row , Metric series	
32900	120~1270	350600	100~1250
32000	100~1270	351000	300~1250
30200	100~1270	351100	300~1250
30300	100~1270	351900	300~1250
31300	120~1270	352000	120~1250
32000	100~1270	352100	110~1250
32200	100~1270	352200	100~1250
32300	100~1270	352900	130~1250
33000	100~1270	Single row, Inch series	
33100	100~1270	IDTB	152.4~939.8
33200	100~1270	Double row, Seal structure	
Single row, Inch series		Whole dimensional range	100~1250
Whole dimensional range	101.6~1016	Double row with steep contact angle	
		DTSA	200~900
		Double row, Inch series with tapered bore	
		IDTT	152.4~571.5



Four row taper roller bearings

Four row taper roller bearings are one of three leading products of SUNBEARING rolling mill bearings and are widely applied to intermediate roll, work roll and backup roll in production lines such as hot rolling, cold rolling, section steel and rod wire steel. This type of bearing can be used for both fixed and floating ends. SUNBEARING newly development with out spacer ring and sealed four row taper roller bearings have already successfully substituted world famous brand of bearings in large scale steel and iron enterprises at home and abroad, making customers more perfectly experience professionalism of SUNBERING rolling mill bearings and the most rational cost performance.



Series	Bore Diameter(mm)
Metric series	
380600	200~1060
381000	200~1060
381100	200~1060
381900	200~1060
382000	140~1060
382900	150~1060
Inch series	
IFTB	120.065~1250
Seal structure	
SFTB	152.4~863.6
Without spacer ring structure	
FTWS	260.35~762





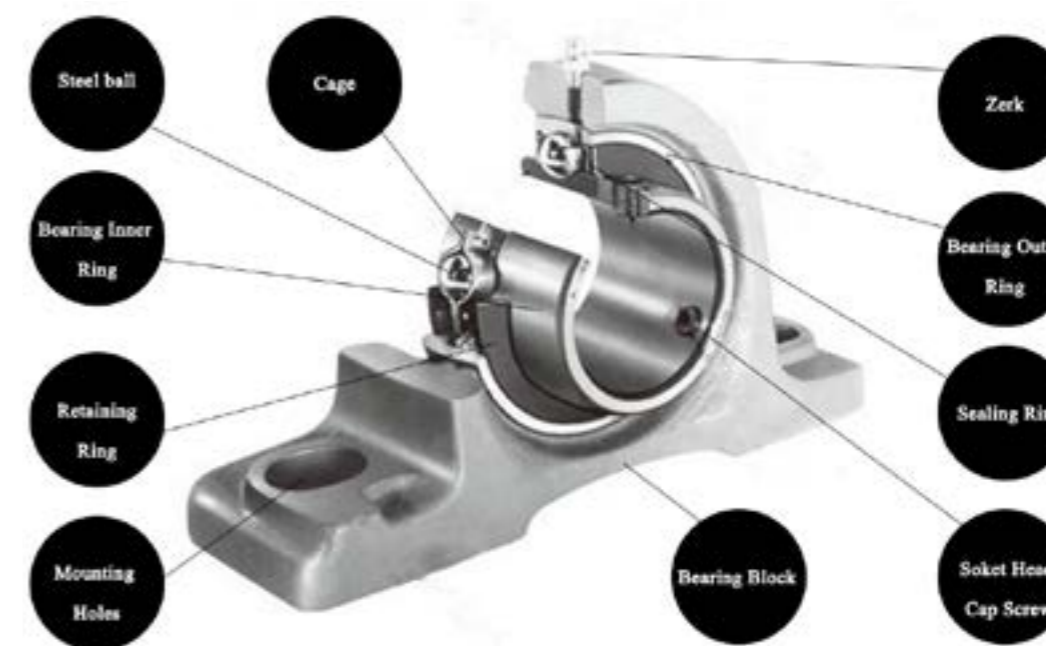
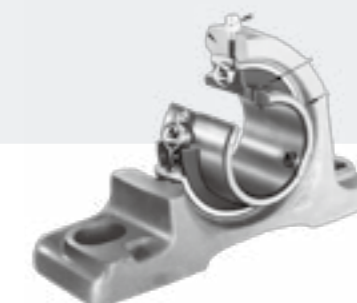

Pillow block bearings

Pillow block bearings constitute by insert bearing and bearing block. The working principle of pillow block bearings is basically same as deep groove ball bearings. Pillow block bearings have performance of automatic aligning. The frame of many main engines can be processed by profiled bar or welded, which not only change the performance of machinery but also reduce the cost.

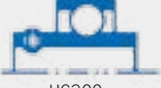
SUNBEARING is good at the production of pillow block bearings. SUNBEARING pillow block bearings have a wide application in the agriculture and the light industry machinery.



带座外球面轴承配套图表

轴承名称 简图号	轴承座名称	铸造立式座	铸造高中心立式座	铸造窄立式座	铸造方形座	铸造可调菱形座	铸造可调菱形座	铸造凸台圆形座	铸造滑块座	铸造环形座	铸造悬挂式座	铸造悬挂式座	铸造凸台方形座	铸造窄菱形座	铸造三角形座	冲压立式座	冲压圆形座	冲压三角形座	冲压菱形座
	简图号	P (Z)	PH (ZH)	PA (ZA)	FU (F) F	FLU (L) FL	FA (LA)	FC (TY)	K (K) T	C (Y)	FB (LB)	HA	FS (TF)	LF (LC)	FT (S)	FP (CZ)	PF (CY)	PFT (CS)	PFL (CL)
带顶丝外球面轴承	 UC200 (90500)	UCP200 (Z90500)	UCPH200 (ZH90500)	UCPA200 (ZA90500)	UCFU200 (F90500) UCF200	UCFLU200 (L90500) UCFL200	UCFA200 (LA90500)	UCFC200 (TY90500) UCT300	UCK200 (K90500) UCT200	UCC200 (Y90500)	UCFB200 (FB90500)	UCFA200 (HA90500)		UCLF200 (LC90500)	UCFT200 (S90500)	UCPP200 (CZ90500)	UCPF200 (CY90500)	UCPFT200 (CS90500)	UCPFL200 (CL90500)
	 UC300 (90600)	UCP300 (Z90600)			UCFU300 (F90600) UCF300	UCFLU300 (L90600) UCFL300			UCK300 (K90600) UCT300	UCC300 (Y90600)			UCFS300 (TF90600)						
	 UB200 (90200)	UBP200 (Z90200)	UBPH200 (ZH90200)	UBPA200 (ZA90200)	UBFU200 (Z90200) UBF200	UBFLU200 (Z90200) UBFL200	UBFA200 (LA90200)	UBFC200 (TY90200)	UBK200 (K90200) UBT200	UBC200 (Y90200)	UBFB200 (FB90200)	UBHA200 (HA90200)		UBFL200 (LC90200)	UBFT200 (S90200)	UBPP200 (CZ90200)	UBPF200 (CY90200)	UBPFT200 (CS90200)	UBPFL200 (CL90200)
带偏心套外球面轴承	 UEL200 (390500)	UELP200 (Z390500)	UELPH200 (ZH390500)	UELPA200 (ZA390500)	UELFU200 (F90500) UELF200	UELFU200 (L390500) UELF200	UELFA200 (A390500)	UELFC200 (TY390500)	UELK200 (K390500) UELT200	UELC200 (Y390500)	UELFB200 (FB390500)	UELHA200 (HA390500)		UELLF200 (LC390500)	UELFT200 (S390500)	UELPP200 (CZ390500)	UELPF200 (CY390500)	UELPT200 (CS390500)	UELPFL200 (CL390500)
	 UEL300 (390600)	UELP300 (Z390600)			UELFU300 (F390600) UELF300	UELFU300 (L390600) UELF300			UELK300 (K390600) UELT300	UELC300 (Y390600)			UELFS300 (TF390600)						
	 UE200 (390200)	UEP200 (Z390200)	UEPH200 (ZH390200)	UEPA200 (ZA390200)	UEPU200 (F390200) UEF200	UEFLU200 (L390200) UEFL200	UEFA200 (LA390200)	UEFC200 (TY390200)	UEK200 (K390200) UET200	UEC200 (Y390200)	UEFB200 (FB390200)	UEHA200 (HA390200)		UELF200 (LC390200)	UEFT200 (S390200)	UEPP200 (CZ390200)	UEPF200 (CY390200)	UEPFT200 (CS390200)	UEPFL200 (CL390200)
带紧定套外球面轴承	 UK200+H (290500)	UKP200+H (Z290500)	UKPH200+H (ZH290500)	UKPA200+H (ZA290500)	UKPU200+H (F290500) UEF200+H	UKFLU200+H (L290500) UKFL300+H	UKFA200+H (LA290500)	UKFC200+H (TY290500)	UKK200+H (K290500) UKT200+H	UKC200+H (Y290500)	UKFB200+H (FB290500)	UKHA200+H (HA290500)		UKLF200+H (LC290500)	UKFT200+H (S290500)	UKPP200+H (CZ290500)	UKPF200+H (CY290500)	UKPFT200+H (CS290500)	UKPFL200+H (CL290500)
	 UK300+H (290600)	UKP300+H (Z290600)			UKFU300+H (F290600) UKF300+H	UKFLU200+H (L290600) UKFL300+H			UKK300+H (K290600) UKT300+H					UKTF300+H (TF290600)					

注: H为紧定套代号, 配用时加在后面, 括号中为旧代号。

18 Years Experience in production



Automatic Equipment

Since 1999, we have been committed to the production and processing of bearings, because of focus, so more professional. Used automated equipment to manufacture and make the professional production personnel, so that our enterprises is growing so fast.

SUNBEARING Group produces over 30,000 kinds of bearings. Customized non-standard bearings ranging from an inner diameter of 100mm to an outer diameter of 2,000mm.

We provide a complete product range covering large, medium and miniature.



Manufacturer Workshop



we have been committed to the production and processing of bearings, because of focus, so more professional. Used automated equipment to manufacture and make the professional production personnel, so that our enterprises is growing so fast.

SUNBEARING Group produces over 30,000 kinds of bearings. Customized non-standard bearings ranging from an inner diameter of 100mm to an outer diameter of 2,000mm.

We provide a complete product range covering large, medium and miniature.





Outer Ring Processing

About our service

1. Since they are both rings of steel, the process starts with steel tubing of an appropriate size. Automatic machines similar to lathes use cutting tools to cut the basic shape of the race, leaving all of the dimensions slightly too large. They can be machined back to their finished size after heat treating.
2. The rough cut races are put into a heat treating furnace at about 1,550 degrees Fahrenheit (843 degrees Celsius) for up to several hours (depending on the size of the parts), then dipped into an oil bath to cool them and make them very hard. This hardening also makes them brittle, so the next step is to temper them. This is done by heating them in a second oven to about 300 degrees Fahrenheit (148.8 degrees Celsius), and then letting them cool in air. This whole heat treatment process makes parts which are both hard and tough.
3. After the heat treatment process, the races are ready for finishing. However, the races are now too hard to cut with cutting tools, so the rest of the work must be done with grinding wheels. At this point, the races are finished, and ready to be put together with the balls.

Roller & ball



BEARING ROLLER PROCESSING

About the project

◆ cold heading or hot heading |

The balls are a little more difficult to make, even though their shape is very simple. Surprisingly, the balls start out as thick wire. This wire is fed from a roll into a machine that cuts off a short piece, and then smashes both ends in toward the middle. This process is called cold heading. Heat upsetting, is the use of medium-frequency heating furnace, anti-rust material heating to about 700 ~ 800 degrees, in the punch forming.

BEARING ROLLER PROCESSING |

The heat treatment process for the balls is similar to that used for the races, since the kind of steel is the same, and it is best to have all the parts wear at about the same rate. Like the races, the balls become hard and tough after heat treating and tempering.

After heat treatment, the balls are put back into a machine that works the same way as the flash remover, except that the wheels are grinding wheels instead of cutting wheels. These wheels grind the balls down so that they are round and within a few ten thousandths of an inch of their finished size. After this, the balls are moved to a lapping machine, which has cast iron wheels and uses the same abrasive lapping compound as is used on the races.

Here, they will be lapped for 8-10 hours, depending on how precise a bearing they are being made for. Since again, the result is steel that is extremely smooth.

→ Our Cage

CAGE

Cage making and product line



Stamped cage

Steel cages are stamped out of fairly thin sheet metal, much like a cookie cutter, and then bent to their final shape in a die. A die is made up of two pieces of steel that fit together, with a hole the shape of the finished part carved inside. When the cage is put in between and the die is closed, the cage is bent to the shape of the hole inside. The die is then opened, and the finished part is taken out, ready to be assembled.

Solid Brass Cage

This type of cage has the ability to absorb shocks. Since brass is soft, it has got a self lubricating property. Secondly brass has a unique property of self adjusting.



Bearings Packing

Now that all of the parts are made, the bearing needs to be put together. First, the inner race is put inside the outer race, only off to one side as far as possible. This makes a space between them on the opposite side large enough to insert balls between them. The required number of balls is put in, then the races are moved so that they are both centered, and the balls distributed evenly around the bearing.

At this point, the cage is installed to hold the balls apart from each other. Plastic cages are usually just snapped in, while steel cages usually have to be put in and riveted together. Now that the bearing is assembled, it is coated with a rust preventative and packaged for shipping.

PACKING

SUNBEARING



SERVICE 01

Commercial packaging: 1pc/plastic bag + color box + carton + pallet



SERVICE 02

Industrial packaging: a). plastic tube + carton + pallet; b). plastic bag + kraft paper + carton + pallet



SERVICE 03

Customized packaging solutions according to customers' requirements



SERVICE 04

High quality rubber cover: waterproof, wear-resisting, high temperature resistant, corrosion resistance



Mining industry Application

SUNBEARING through in-depth understanding of the mining industry, targeted integration of mining system and equipment accessories, mainly including bearings, seals, etc., can meet the different needs of mining industry equipment. High-quality and reliable transmission products, timely professional technical services, convenient and efficient one-stop business platform. SUNBEARING is the mining company's preferred choice for driving product solutions.

Roller Press



Rig

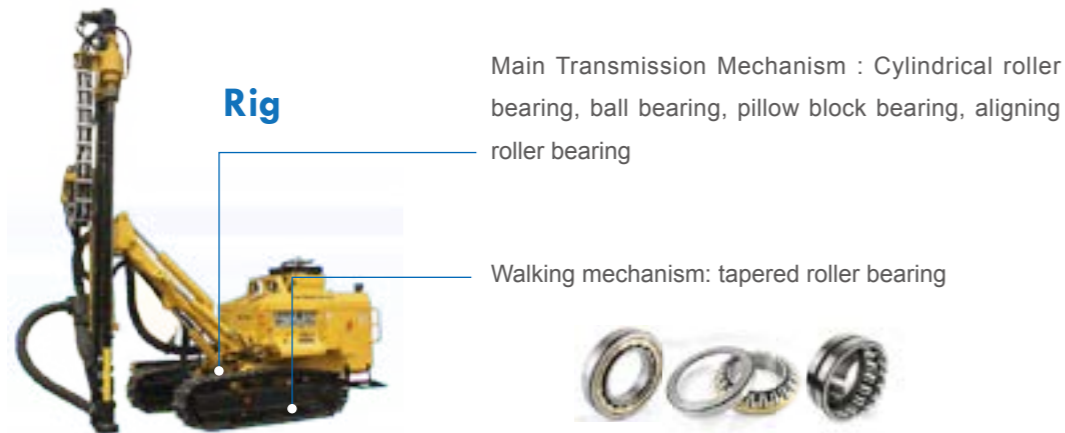

Belt conveyor



Mining industry Application

SUNBEARING high-end power product integration solution provides metallurgical manufacturing enterprises with high-quality spare parts required for equipment maintenance, helps enterprises save the cost of procurement and supply management of spare parts, and ensures the stable operation of production. Bearing legacy brands, premium products, and timely and professional technical services, SUNBEARING is the metallurgical enterprise's best choice to seek solutions for transmission products.

Blast furnace blower

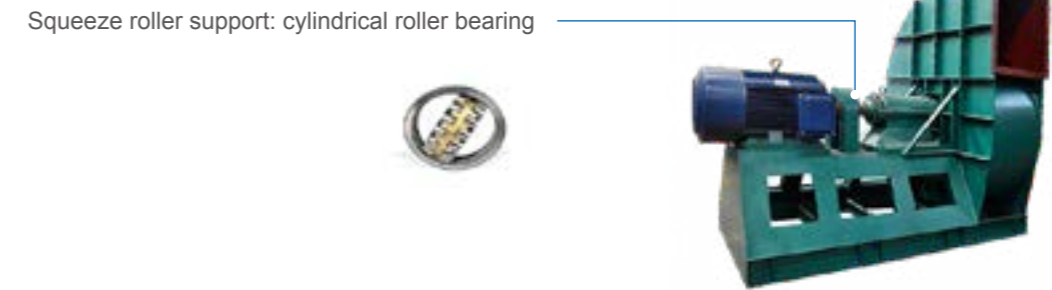

Cold rolling mill



Roller bed

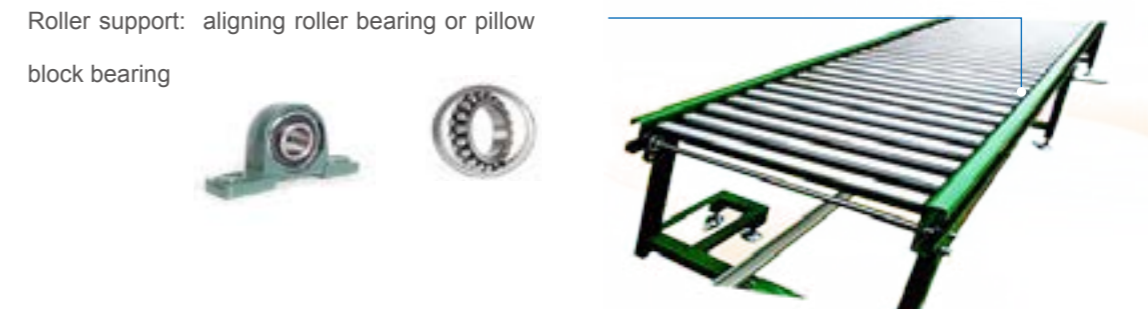

Why choose us?

We know the situation of bearing industry very well. In China, we used to match bearing for many mechanical equipment. With rich experience in bearing supporting, such as engine bearing, engine accessory bearing, transmission bearing, dental bearing, YO-YO bearing, mining machinery bearing ,agriculture machinery bearing ,food machinery bearing and etc. We can match high-quality bearing products for customers and save costs, which is our biggest advantage.

Professional cage production enables us to reduce costs and improve quality of important factors

They all choose us

- 

● In March,2001, successfully cooperated with Konica (Dalian) co., LTD.
- 

● In 2001, Cooperation with Toshiba TV (Dalian) co. LTD
- 

● In March ,2001, Cooperation with Fuji electric (Dalian) co. LTD.
- 

● In April,2003,Cooperation with TDC cutting tools (Dalian) co. LTD
- 

● In April 2005, cooperation with Dongbei Special Steel Group Co., Ltd. (DSSC)(Dalian) co. LTD.
- 

● On July 8,2006, cooperation with Tianyu company in Ningbo

They all choose us



● On January 1,2011, signed agent of TIMKEN bearings in southern Liaoning with FirstBridge (Shanghai) Trading Co.,Ltd.



● In March,2013,establish cooperation with CIMC (Dalian) container co. LTD.



● In July,2013, establish cooperation with Dalian Hongyuan aluminium company limited.



● On February 2 ,2014, sign contract with Dongguan KIRIN machinery company limited



● In May ,2014,cooperation with Giantech (Dalian) automobile parts company limited.



● In July ,2014,cooperation with Liwa (Dalian) pump company limited.



● In March,2017,sign to be agent of the chain with Hangzhou Unibear company limited in Dalian.



● In March,2017,cooperate with ETDZ Senggang machinery company.



My Clients

Every year there are different customers to visit factory, customers from different countries, different color, different languages are bearing quality pursuit, in order to obtain high quality bearing products, we adhere to the "first-class brand, quality service", and cooperate with the world well-known brand, TIMKEN (USA), SKF (Sweden), FAG (Germany), etc.

Through continuous market research and product upgrading, SUNBEARING can better serve you!

Exhibition

SUNBEARING has taken part in many exhibitions and enjoys a high reputation in China. It also takes part in large exhibitions in Shanghai, Guangzhou, Shenzhen and other cities. SUNBEARING is located in Dalian. Because of its geographical location, in the exhibition of Dalian, we are more famous. Many foreign customers come to know us through exhibitions and form long-term cooperative relations.

SUNBEARING has adhered to do everything for the customers, to satisfy the customers and to serve the customers. We will spare no efforts to provide high quality products, advanced technology and perfect service.



My Clients

Our team is not only at the forefront of the industry in terms of technology, we pay more attention to the communication with customers, the accuracy and timeliness of product expression. Professional technicians and professional communicators make up an excellent team. We sincerely serve you!

